

Seal-Tite®
DUCT, PIPE & FITTINGS

The Most Efficient
Air Distribution
System!

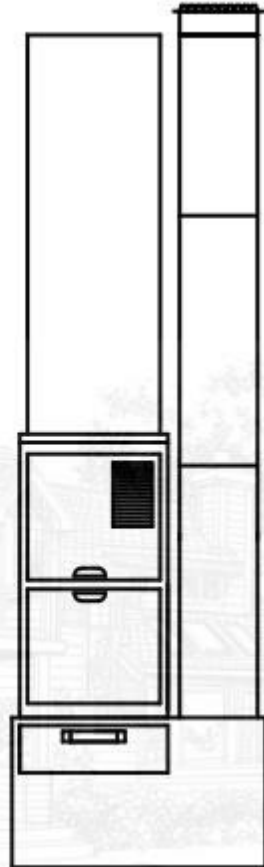

**Air
Management
Products
Catalog**



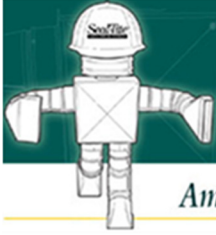

Seal-Tite®
DUCT, PIPE & FITTINGS



America's Premier Air Distribution Systems

Return Air Drop Packages (Kits) Includes Top Collar, 2 sections of Duct and Return Air Boot in one Package

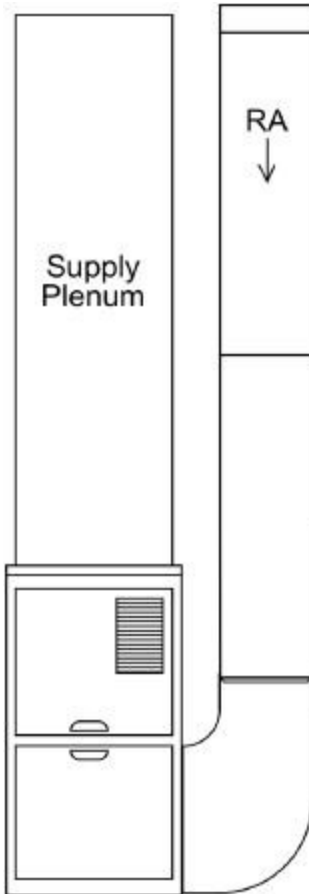

Model Numbers

No. 81100

No. 81100SF

No. 81104

No. 81243

No. 81055

Model No. 81243
shown here

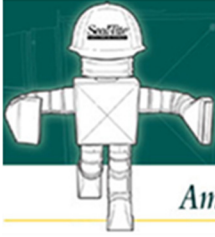

Seal-Tite®
DUCT, PIPE & FITTINGS



America's Premier Air Distribution Systems

Drop Kit with 1" Top Filter Access

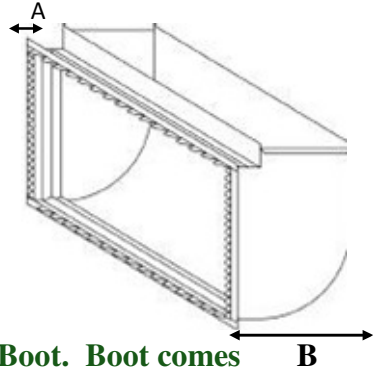
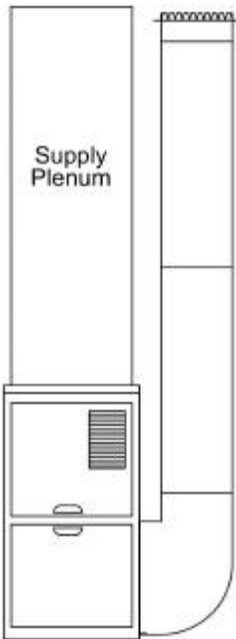

Kit Includes:

No. 248 Return Air Boot. Boot comes dovetailed, with 1/2" flange around all four sides and fully enclosed corners for easy sealing and perfect leak tight fit. Boot accommodates 1" filter with top access.

Two sections of 32" duct.

Model #1200 Top Take off.

Part Number	Filter Size	Duct Size	A	B
4G081100201014	20x14	20x10	4	14
4G081100201620	20x16	20x8	4	12
4G081100201000	20x16	20x10	4	14
4G081100202010	20x20	20x10	4	14
4G081100202514	20x25	25x14	4	18
4G081100242510	14x14	25x10	4	14
4G081100252514	25x12	25x14	4	18
4G081100251014	25x14	25x10	4	14
4G081100251000	25x16	25x10	4	14
4G081100251612	25x16	25x12	4	16
4G081100252025	25x20	25x10	4	14
4G081100252012	25x20	25x12	4	16
4G081100201610	20x16	20x10	4	14
4G081100251610	25x16	25x10	4	14

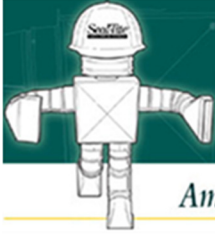

Seal-Tite®
DUCT, PIPE & FITTINGS



America's Premier Air Distribution Systems

Drop with 1" Side Filter Access

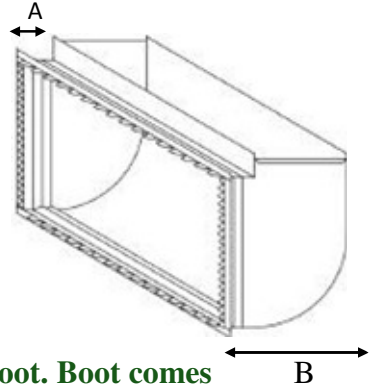
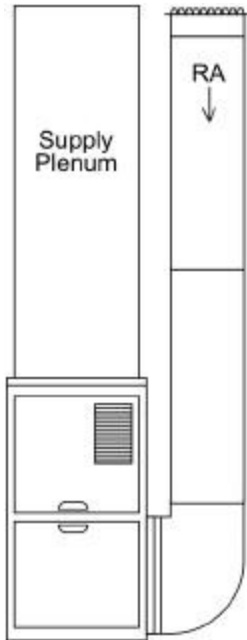

Kit Includes:

248SF Return Air Boot. Boot comes dovetailed, with 1/2" flange around all four sides and fully enclosed corners for easy sealing and perfect leak tight fit. Boot accommodates 1" filter with side access.

Two sections of 32" duct.

Model No. 1200 Top Take off.

Part Number	Filter Size	Duct Size	A	B
4G8110023140SF	25x16	25x10	8 1/4	18 1/4
4G8110020140SF	20x14	20x10	5 1/2	15 1/2
4G8110020160SF	20x16	20x10	6	16
4G8110024140SF	24x14	24x10	5 1/2	15 1/2
4G8110024160SF	24x16	24x10	5 1/2	15 1/2
4G8110025100SF	25x14	25x10	5 1/2	15 1/2
4G8110025140SF	25x14	24x10	5 1/2	15 1/2
4G8110025160SF	25x16	25x10	5 1/2	15 1/2

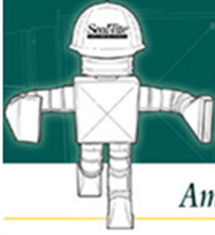

Seal-Tite
DUCT, PIPE & FITTINGS



America's Premier Air Distribution Systems

Drop Kit with 4" Top Filter Access and Hinged Door

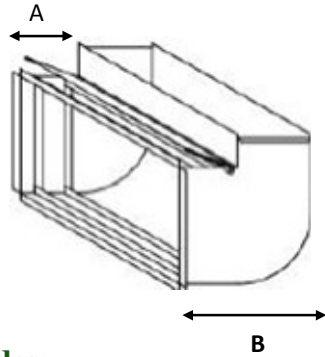
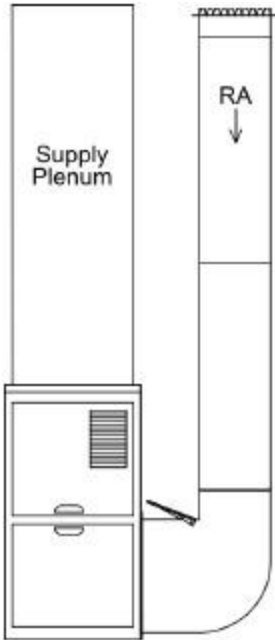

Kit Includes:

One Return Air Boot that accommodates filters up to 6" thick. The Return Air Boot is flanged. Filter access on top.

Two sections of 32" long duct.

Model No. 1200 top take off.

Part Number	Filter Size	Duct Size	A	B
4G081104201610	20x16	20x10	9	19
4G081104251610	25x16	25x10	9	19

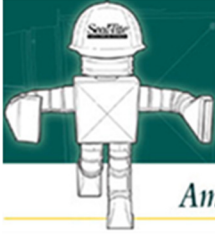

Seal-Tite®
DUCT, PIPE & FITTINGS



America's Premier Air Distribution Systems

Model No. 81243 High Efficiency Return Air Drop Kit

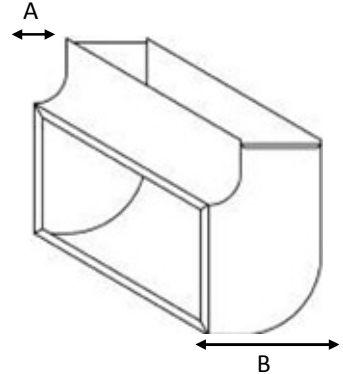
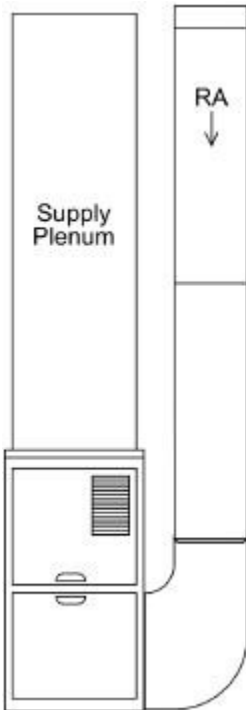

Kit Includes:

Model No. 8243 Return Air Elbow with inside throat and outside back radius for most efficient airflow and the least turbulence. 1" flange turned in on all 4 sides and "S" Cleats for easy attachment to the unit.

Two sections of 32" duct.

Model No. 1200 Top Take off.

No. 81243 complements:

**No. 243 Filter Rack
(Sold Separately)
and**

**IFR In-Line Filter Rack
(Sold Separately)
(See Filter Rack section
of this catalog).**

Part Number	Filter Size	Duct Size	A	B
4G812432008014	20x14	20x8	4	12
4G812432010014	20x14	20x10	4	14
4G812432010016	20x16	20x10	4	14
4G812432410014	24x14	24x10	4	14
4G812432508016	25x16	25x8	4	12
4G812432510014	25x14	25x10	4	14
4G812432510016	25x16	25x10	4	14
4G812432512016	25x16	25x12	4	16
4G812432512200	25x20	25x12	4	16

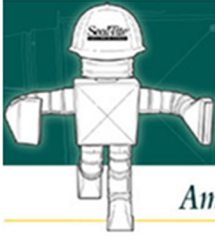

Seal-Tite®
DUCT, PIPE & FITTINGS



America's Premier Air Distribution Systems

Model No. 81055 Larger Tonnage Return Air Drop Kit

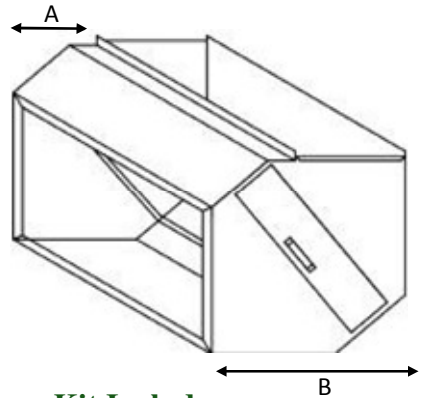
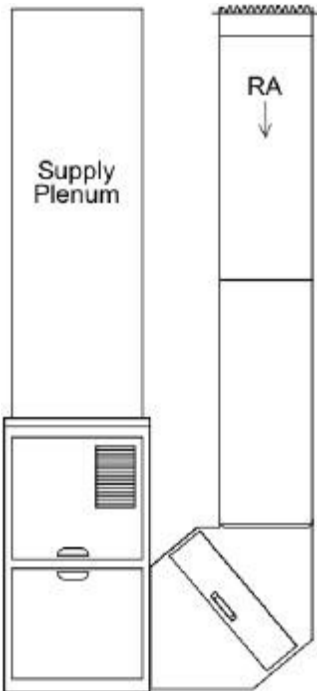

Kit Includes

Model No. 055 Return Air Boot with 1" flanges turned in on all 4 sides. Filter drawer holds up to 5" filter.

Two sections 10" x 25" x 32" Duct

Model No. 1200 Top Take Off Collar

Part Number	Filter Size	Duct Size	A	B
4G810552025251	20x25	25x10	6	16

*Can be used with 2-5
TON Units with Low
Pressure Drop

055 Boot Only

Part Number	Filter Size	Duct Size	A	B
4G055020252510	20x25	25x10	6	16



Section #2

Return Air Boots

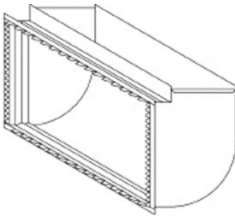

Model No. 248
1" Top Filter Access

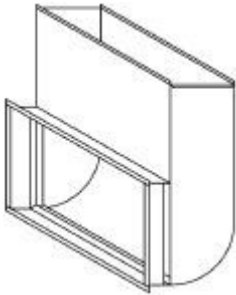

Model No. 248C
1" Side Filter Access
With Long Neck (19.75")

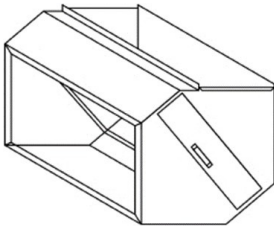

**Model No. 055 – 20x25-
25x10 4" Filter drawer**
Designed for 2-5 ton units
with low pressure drop

Available Sizes

Filter Size	Duct Size
20x14	20x8
20x14	20x10
20x16	20x8
20x16	20x10
24x14	24x8
24x16	24x8
24x20	24x10
25x16	24x10
25x16	25x8
25x16	25x10
25x20	25x10

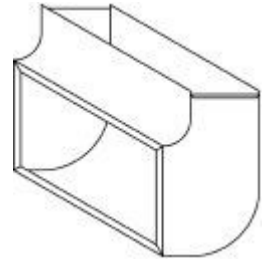

Model No. 8243
Maximum Efficiency
4" Radius Throat

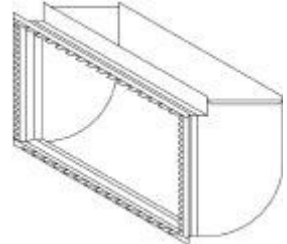

Model No. 248SF
1" Side Filter Access
1" flange out

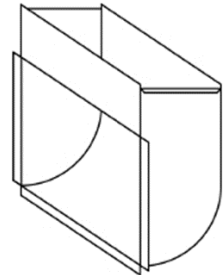

Model No. 248FA Stub Boot
For slimmest profile
Available in
8x25 - 16x25
10x25 - 20x25

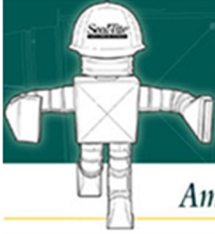

Section #3

Filter Frames



Model No. 243
1" – 4" filters

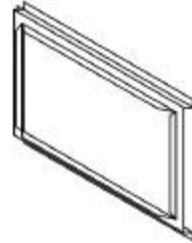

Model No. 253
screw in 1" filter frame

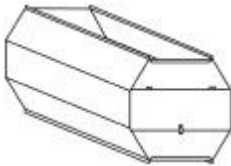

IFR
In-Line Filter Rack
(see next page)

Available Sizes

14x20
14x25
16x20
16x25
20x20
20x24
20x25



Model No. 254
4" wide, 1" flange in, 1" hinged door

Model No.251
1" filter w/dovetails on one side
251HD – with hinged door
251SD – with sliding door

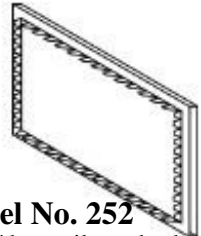

Model No. 252
1"filter w/dovetails on both sides



Model No. 249
1" screw in filter frame w/door

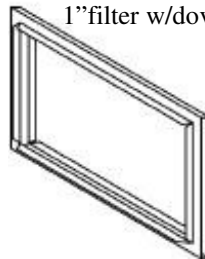

Model No. 250
1" filter without dovetail

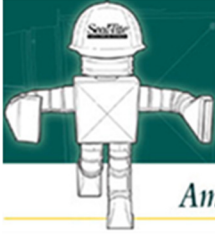

Seal-Tite
DUCT, PIPE & FITTINGS



America's Premier Air Distribution Systems

Model No. IFR In-Line Filter Rack

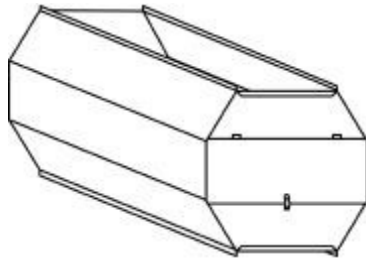
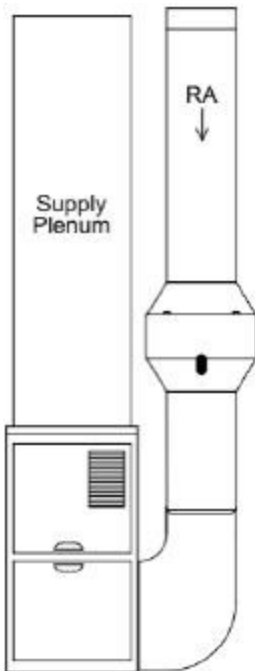

Model No. IFR is designed for easy installation between 2 sections of duct where mounting to the furnace is not possible either due to space requirements or requisite piping. This design promotes maximum airflow and spreads the air flow evenly over the entire surface of the filter greatly improving its performance. Filter sizes from 1" to 6" can be used for maximum flexibility. The filter door is fitted with a gasket and mechanical latch to eliminate all leakage.

Available Sizes

Duct Size	Filter Size
24x8	24x14
20x10	20x16
24x10	24x16
25x10	25x16
24x12	24x20



Seal-Tite
DUCT, PIPE & FITTINGS



America's Premier Air Distribution Systems

Section #4

Return Air Support Cabinets

No. 92H

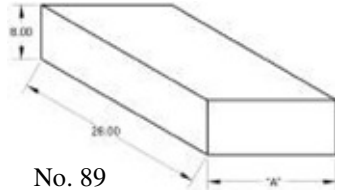
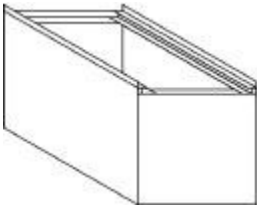

No. 89

Model No.

92H

96

925FD

WK30 & WK38

WKF

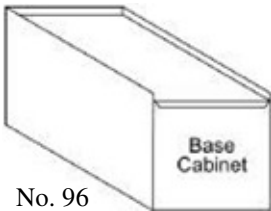

No. 96

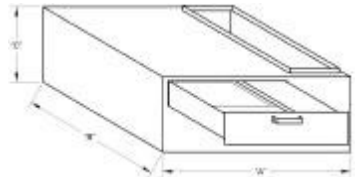

No. WKF

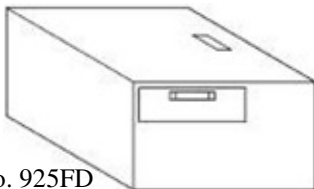

No. 925FD

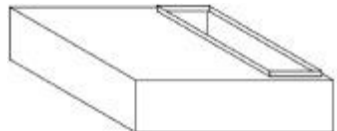

No. WK30

No. WK38

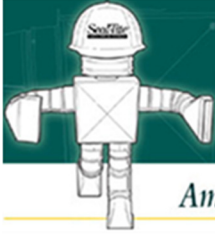

Seal-Tite®
DUCT, PIPE & FITTINGS



America's Premier Air Distribution Systems

Model No. 92F and Model No. 92H Return Air Support Cabinet with slide in filter rack

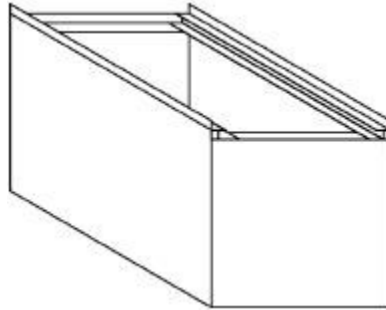
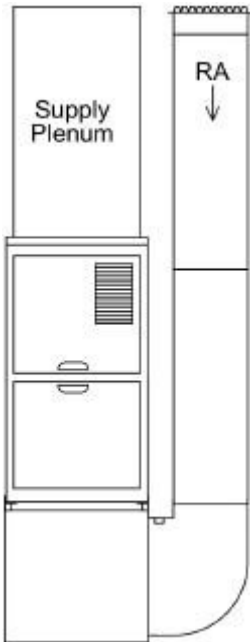

Part Number	Width	Depth	Height	Filter size
4R92F226145612	14 1/4	22	12	14x20
4R92F175822162	17 1/4	22	12	16x20
4R92F022141418	14 1/4	22	18	14x20
4R92F226211818	21 1/4	22	18	20x20
4R92H141414250	14 1/4	25	24	14x25
4R92H173416200	17 3/4	20	24	16x20
4R92H173416250	17 3/4	25	24	16x25
4R92H211420200	21 1/4	20	24	20x20
4R92H211420250	21 1/4	25	24	20x25
4R92H250250200	25	20	24	20x25

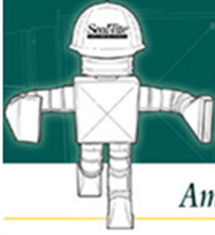

Seal-Tite®
DUCT, PIPE & FITTINGS



America's Premier Air Distribution Systems

Model No. 96 Return Air Support Cabinet Knocked Down Easy to Assemble

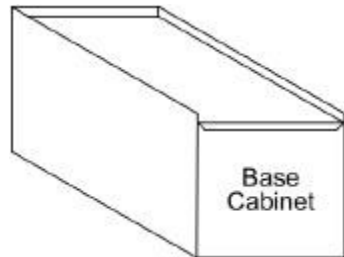
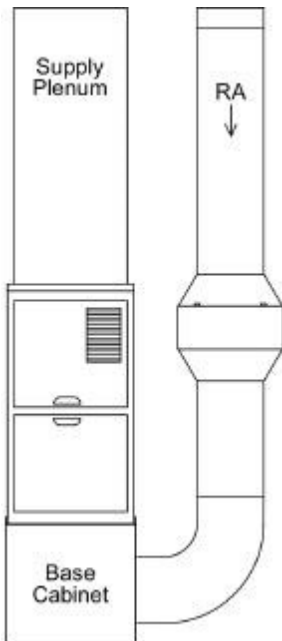

Model No. 96 Support Cabinet
This cabinet comes knocked down
requiring less storage space and is
easy to assemble.

Shown with Model No. IFR

Instructions:

- 1. Slip all four sides together.**
- 2. Add the top and bottom cap and punch lock together.**
- 3. Can easily be cut for up-flow return.**

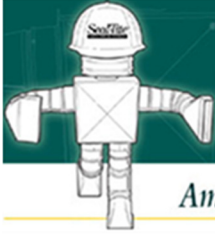

Seal-Tite®
DUCT, PIPE & FITTINGS



America's Premier Air Distribution Systems

Model No. 96 Return Air Support Cabinet Knocked Down Easy to Assemble

Part Number	Width	Depth	Height
4R961434223618	14 3/4	22 1/4	18
4R962814141418	14 1/4	28 3/4	18
4R961434223124	14 3/4	22 1/4	24
4R961458283424	14 3/4	28 3/4	24
4R962114173418	17 3/4	21 3/4	18
4R961778221618	17 3/4	22 1/4	18
4R962814173418	17 3/4	28 3/4	18
4R961778223124	17 3/4	22 1/4	24
4R861734283424	17 3/4	28 3/4	24
4R962114211418	21 1/4	21 1/4	18
4R962138221618	21 1/4	22 1/4	18
4R962814211418	21 1/4	28 1/4	18
4R962138223124	21 1/4	22 1/4	24
4R862114283424	21 1/4	28 1/4	24
4R962251621381	22 1/4	21 1/4	18
4R962414221418	22 1/4	24 1/4	18
4R962434211418	24 3/4	21 3/4	18
4R962451622318	24 3/4	22 1/4	18
4R962434283418	24 3/4	28 3/4	18
4R962456223124	24 3/4	22 1/4	24
4R962434283424	24 3/4	28 3/4	24

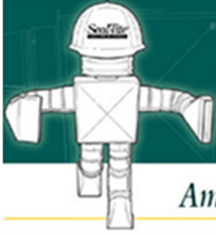

Seal-Tite®
DUCT, PIPE & FITTINGS



America's Premier Air Distribution Systems

Model No. 925FD Return Air Support Cabinet W/Filter Drawer

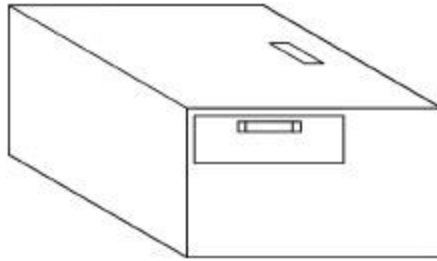
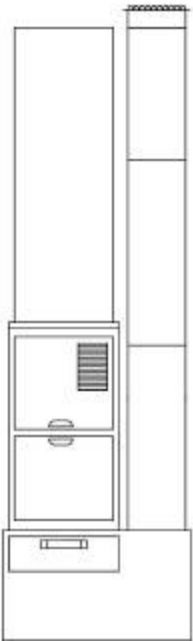

No. 925FD Support Cabinet with Filter Drawer

**Cover plate on other side allows filter access to be from either end.
Drawer for 1"-5" filter.**

Part Number	Width	Depth	Height	Filter Size
4R925FD228515	32	28 1/2	15	20x25x5
4R925FD398519	39	28 1/2	19	20x25x5

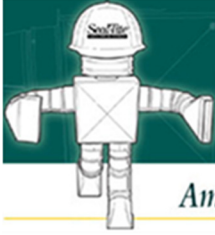

Seal-Tite®
DUCT, PIPE & FITTINGS



America's Premier Air Distribution Systems

Model No. WK 30 and WK 38 Return Air Support Cabinet Without Filter Rack

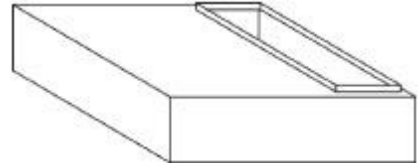
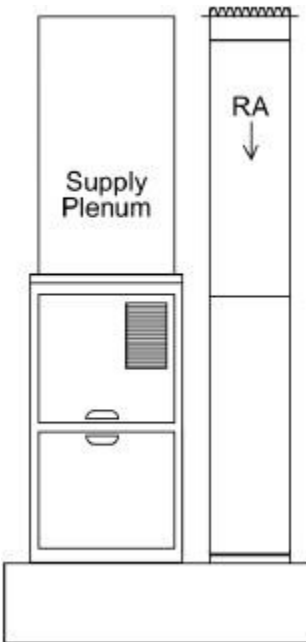

No. WK 30 Support Cabinet is 30" wide and 28" deep. With or without duct opening

Part Number	Width	Depth	Height	Duct Size
4R030281002010	30	28	10	20x10
4R030281002408	30	28	10	24x8
4R030281002508	30	28	10	25x8

No. WK 38 Support Cabinet is 38" wide and 28" deep. With or without duct opening

Part Number	Width	Depth	Height	Duct Size
4R038281002408	38	28	10	24x8
4R038281002410	38	28	10	24x10
4R038281002510	38	28	10	25x10

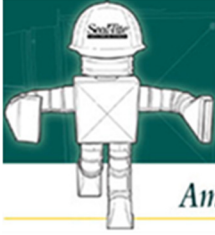

Seal-Tite®
DUCT, PIPE & FITTINGS



America's Premier Air Distribution Systems

Model No. WKF Return Air Support Cabinet with Filter Drawer

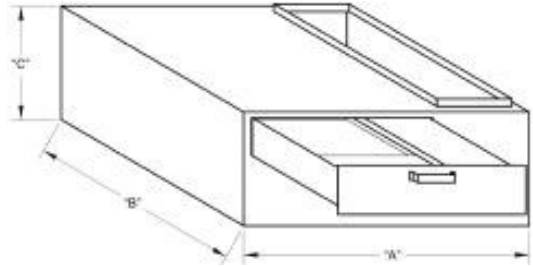
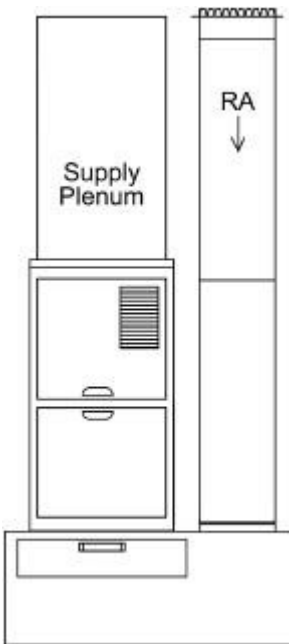

WKF Support Cabinet with Filter Rack
22x28 drawer accommodates
1", 4" and 5" 22x25 filters

Part Number	A	B	C	Duct Size
4R0302815F2408	30	28	15	24x8
4R0322815F2408	32	28	15	24x8
4R0362815F2510	36	28	15	25x10
4R0382815F2510	38	28	15	25x10
4R0392819F2412	39	28	19	24x12
4R0392819F2510	39	28	19	25x10

Call for a quote

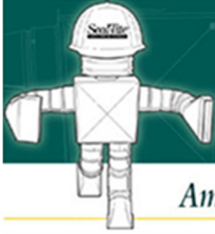

Seal-Tite
DUCT, PIPE & FITTINGS



America's Premier Air Distribution Systems

Model No. 89 Support Cabinet

With Oversized RA Elbow

For Higher Tonnage Units

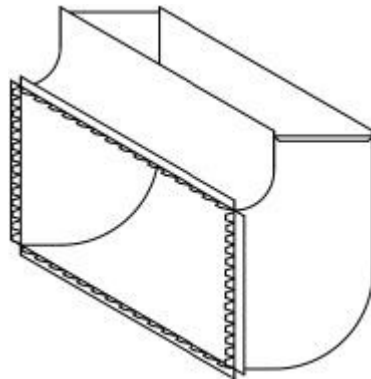
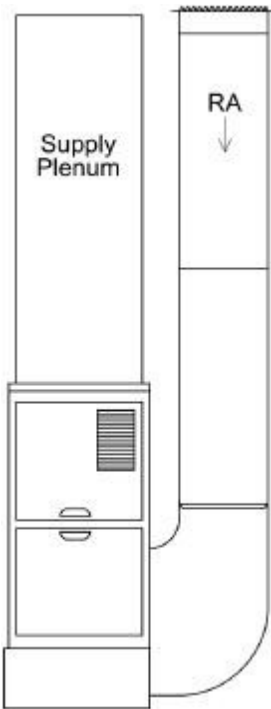

Model No. 148NF 20x25 to 12x25 Elbow Boot

This basic base cabinet is designed for a large return air boot to be utilized as a side and bottom return. Cut metal for base and side at least one inch from edge. For best results cut top support flange closest to RA Boot 1 1/2" and bend 1/2" flange down for additional support. Screw from blower compartment, unit to base cabinet.

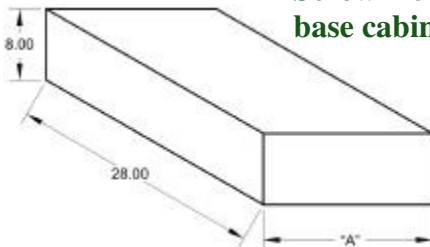

"A"
14 1/2"
17 1/2"
21"
24 1/2"

Call for a quote

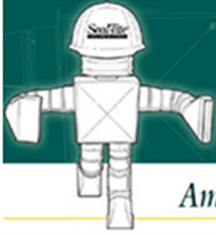

Seal-Tite®
DUCT, PIPE & FITTINGS



America's Premier Air Distribution Systems

Mr. Seal-Tite

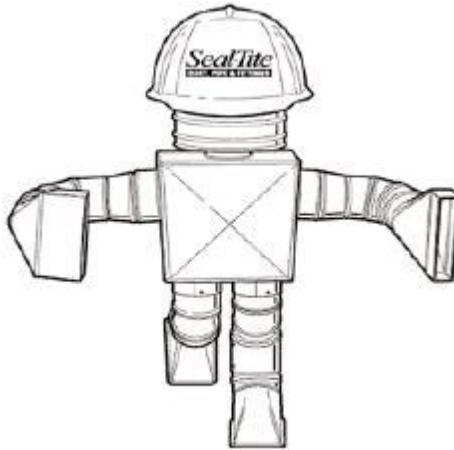

**Have one made for your store today.
\$250.00**

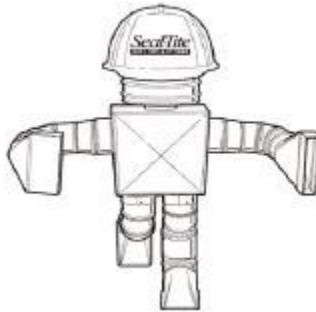

Authorized Distributor of Seal-Tite Products

Seal-Tite[®]
DUCT, PIPE & FITTINGS

SEAL-TITE, LLC
120 Moore Rd. Hillsboro, OH 45133
800 582-9025

PENNSYLVANIA DISTRIBUTION
CENTER 770B Maple St. Lebanon, PA
17046

www.sealtitehvac.com